

Hazardous Location Applications



WARNING:

- **Hazardous Locations**
- It is the user's responsibility to ensure that all local, state, and national laws, rules, codes, or regulations relating to the installation and use of this device in any particular application are satisfied. This device must be installed by Qualified Persons, in accordance with this document and applicable regulations.
- A Qualified Person is a person who, by possession of a recognized degree or certificate of professional training, or who, by extensive knowledge, training and experience, has successfully demonstrated the ability to solve problems relating to the subject matter and work.



WARNING: The hazardous location mounting hardware is designed to help protect the HLS27 light from damage during impact and must be used in all hazardous location applications. Failure to use the Banner supplied mounting hardware correctly will void the hazardous location rating of the light.



CAUTION:

- **Electrostatic Discharge (ESD) Special Conditions for Safe Use**
- Parts of the enclosure are non-conducting and can generate an ignition-capable level of ESD.
- Clean the equipment with only a damp cloth.

General Notes and Conditions for Safe Use:

- See Specifications and Wiring Diagrams for important information concerning entity parameters, permissible locations, electrical connections and certifications.
- In addition to the warning above concerning user responsibility, the installation must comply with the following:
 - All installations must comply with all manufacturer's instructions.
 - This device is provided with a PLTC-ER/ITC-ER cable and must be installed in accordance with the following:
 - NEC Article 501.10 (B) for Class I Division 2
 - NEC Article 502.10 (B) for Class II Division 2
 - NEC Article 503.10 (A) or (B) for Class III Division 1 or 2 respectively
 - Canadian Electrical Code (CSA C22.1) for Canadian Installations
 - Section 9 of IEC 60079-14 for ATEX/IECEx locations
 - The PLTCER/ITC-ER cable shall be installed in accordance with the provisions of NEC Article 725 (PLTC-ER) or 727.4 (ITC-ER) for Class I Division 2, Class II Division 2, and Class III Division 1 and 2 locations
 - The cable shall be terminated with a fitting certified for the appropriate location classification
 - The device must be powered by a class 2 power supply
- Do not attempt any repairs to this device; it contains no field-replaceable parts or components. Tampering and/or replacement with non-factory components may adversely affect the safe use of the system.
- The nonconducting materials of this device may be susceptible to ignition-capable level of electrostatic charging and precautions must be taken to avoid this. The user/installer shall ensure that the equipment is not installed in a location where it may be subjected to external conditions (such as high-pressure steam) which are conducive to creating a build-up of electrostatic charges.
- The user/installer must take suitable precautions to prevent the device from being adversely affected by aggressive substances, such as acidic liquids or gases that may attack metals, or solvents that may affect polymeric (plastic) materials. Suitable precautions include routine inspection or maintenance procedures require replacement of damaged devices or establishing from the materials data sheet that the device is resistant to specific chemicals. These precautions must ensure that the type of protection is not compromised.

Wiring Diagram

	Wire Color	Single Color Models	Dual Color Models	PWM Models
	1 - Brown	12 V dc to 30 V dc	Color 1: 12 V dc to 30 V dc	12 V dc to 30 V dc
	3 - Blue	dc common	dc common	dc common
	4 - Black	Connect to 12 V dc to 30 V dc for 50% intensity. For 100% intensity, leave the black wire floating or connected to common.	Color 2: 12 V dc to 30 V dc (color 2 overrides color 1)	Pulse width modulation (PWM) input. For maximum intensity, leave the black wire floating or connected to common. Connecting to 12 V dc to 30 V dc will cause LEDs to shut off.
	2			

Mounting Instructions

Multiple mounting options are available for the HLS27 in hazardous locations. In the two options listed below, the mounting brackets must be spaced a distance of (L4) apart to ensure the device meets impact protection standards for hazardous locations.

Included Mounting Hardware (LMBHLS27S – 2 Brackets)

When using the standard mounting hardware, the mounting hole centers for each individual bracket must be spaced 50.0 mm (1.97 inches) from one another. This spacing is critical for the bracket to provide the required impact protection and prevent rotation of the light within the bracket.

The stainless-steel bracket is designed to be used with M5 or #10 stainless-steel hardware.

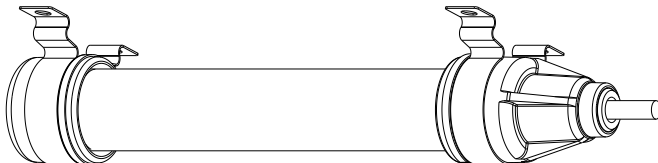
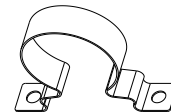

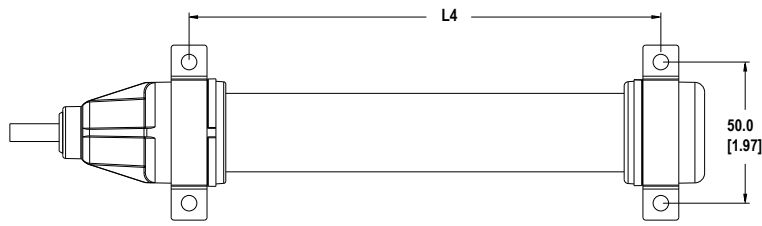

Models	L4
HLS27..0145..	168 mm (6.6 in)
HLS27..0285..	309 mm (12.2 in)
HLS27..0430..	450 mm (17.7 in)
HLS27..0570..	591 mm (23.3 in)
HLS27..0710..	732 mm (28.8 in)
HLS27..0850..	873 mm (34.4 in)
HLS27..0990..	1014 mm (39.9 in)
HLS27..1130..	1155 mm (45.5 in)

Optional Mounting Hardware (LMBHLS27O – 2 Brackets and Hardware) Purchased Separately

When using the optional mounting hardware, the head of the fastener used must not exceed 5.0 mm (0.2 inches) in height. Fasteners exceeding this height could damage the light housing during impact situations.

When using the optional mounting hardware, the supplied spacer must be used with the bolt to maintain the correct bracket shape. This shape is critical for the bracket to provide the required impact protection.

The stainless-steel bracket is designed to be used with M5 or #10 stainless-steel hardware.

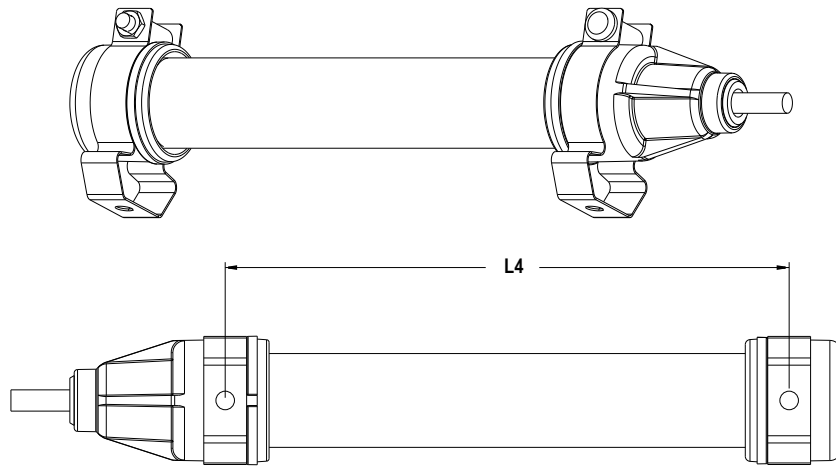
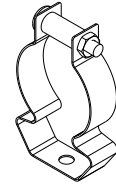

Models	L4
HLS27..0145..	168 mm (6.6 in)
HLS27..0285..	309 mm (12.2 in)
HLS27..0430..	450 mm (17.7 in)
HLS27..0570..	591 mm (23.3 in)
HLS27..0710..	732 mm (28.8 in)
HLS27..0850..	873 mm (34.4 in)
HLS27..0990..	1014 mm (39.9 in)
HLS27..1130..	1155 mm (45.5 in)

Light Anti-Rotation Pads

In applications where vibration is a concern or when light orientation is critical, use anti-rotation pads to prevent the light from rotating within the mounting brackets. Light rotation caused by vibration may be more pronounced with longer length lights.

Attach the anti-rotation pads to the brackets, as shown in the figures, with the adhesive side applied to the bracket.

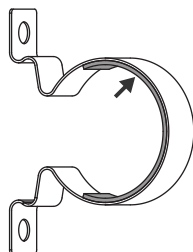

Figure 1. Included Mounting Hardware with Anti-Rotation Pads



Note: When using the optional mounting hardware, cut the anti-rotation pad and apply it to both sides of the mounting bracket as shown.

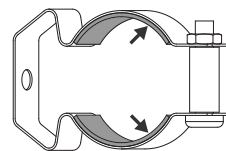

Figure 2. Optional Mounting Hardware with Anti-Rotation Pads

Specifications

Supply Voltage

12 V dc to 30 V dc
Use only with suitable Class 2 power supply

Light Length	Typical Current			Max. Current
	12 V dc	24 V dc	30 V dc	A
145 mm	0.33 A	0.15 A	0.12 A	0.4
285 mm	0.66 A	0.30 A	0.24 A	0.8
430 mm	1.01 A	0.46 A	0.36 A	1.2
570 mm	1.36 A	0.61 A	0.48 A	1.6
710 mm	1.75 A	0.77 A	0.60 A	2.0
850 mm	2.13 A	0.92 A	0.73 A	2.4
990 mm	2.59 A	1.08 A	0.85 A	2.8
1130 mm	3.04 A	1.24 A	0.97 A	3.2

Environmental Rating

IEC IP66, IEC IP67

Operating Temperature

For NEC & CEC applications: -40 °C to +60 °C (-40 °F to +140 °F)
For ATEX/IECEX applications: -40 °C to +50 °C (-40 °F to +122 °F)
90% maximum relative humidity (non-condensing)
Light output begins to decrease above 50 °C (122 °F) and will be approximately 65% of maximum intensity of 60 °C (140 °F)
Storage Temperature: -40 °C to +70 °C (-40 °F to +158 °F)

Vibration and Mechanical Shock

Vibration: 10 Hz to 55 Hz, 1.0 mm peak-to-peak amplitude per IEC 60068-2-6
Shock: 15G 11 ms duration, half sine wave per IEC 60068-2-27

Supply Protection Circuitry

Protected against reverse polarity and transient voltages

Pulse Width Modulation (PWM Models Only)

Frequency: Up to 1000 Hz
Voltage: 8 V dc to 30 V dc
Current: 4 mA maximum per foot

LED Lifetime

Lumen Maintenance - L₇₀
When operating within specifications, output will decrease less than 30% after 50,000 hours

Construction

Clear anodized aluminum housing; UV stabilized polycarbonate outer housing

Mounting

Bracket kit LMBHLS27S included (2 brackets for use with HLS27 Hazardous Location LED Strip Light)
Optional bracket kit LMBHLS27O (2 brackets and hardware for use with HLS27 Hazardous Location LED Strip Light)

Connections

2 m (6.3 ft) long, 6.3 mm (0.25 inch) diameter ITC-ER cable with unterminated leads; pressured EX60 jacket (type ST2 per IEC 60092-360:2014), paper separator, filler as needed, compliant with 60332-3-22; UL TC-ERDB, ITC, PLTC, ERDB, IEEE 1580-2010, ABS

Approvals

NEC and CEC:
-40 °C ≤ T_a ≤ +60 °C
Gas & Vapors: Class I Zone 2 IIC T4 / Class I Div 2 Groups ABCD T4
Dust: Class II Zone 22 IIIC T100 °C / Class II Div 2 Groups FG T5
Fibers: Class III Div 1 and Div 2 T5

ATEX/IECEX:

-40 °C ≤ T_a ≤ +50 °C
Gas & Vapors: II 3 G Ex ec IIC T4 Gc (Group IIC Zone 2)
Dust: II 3 D Ex tc IIIC T85 °C Dc (Group IIIC Zone 22)



UL/cULus E467619



IECEX UL 18.0115X : DEMKO 18 ATEX 2122X



Light Characteristics – Single Color Models

Cool White Efficacy: 104 lumens/Watt typical at 24 V dc at 25 °C (77 °F)
CRI: 85, typical

Color	Dominant Wavelength (nm) or Color Temperature	Lighted Length Lumens (Typical at 25 °C)							
		145 mm	285 mm	430 mm	570 mm	710 mm	850 mm	990 mm	1130 mm
Cool White	6500 K (+ 600 K/- 500 K)	375	750	1125	1500	1875	2250	2625	3000
Warm White	3000 K (+ 250 K/- 150 K)	375	750	1125	1500	1875	2250	2625	3000
Green	525 nm	205	410	615	820	1025	1230	1435	1640
Red	618 nm	65	130	195	260	325	390	455	520
Yellow	590 nm	55	110	165	220	275	330	385	440
Blue	460 nm	45	90	135	180	225	270	315	360

Light Characteristics – Dual Color Models

Daylight White Efficacy: 76 lumens/Watt typical at 24 V dc at 25 °C (77 °F)
CRI: 83, typical

Color	Dominant Wavelength (nm) or Color Temperature	Lighted Length Lumens (Typical at 25 °C)							
		145 mm	285 mm	430 mm	570 mm	710 mm	850 mm	990 mm	1130 mm
Daylight White	5000 K (± 300 K)	275	550	825	1100	1375	1650	1925	2200
Green	525 nm	175	350	525	700	875	1050	1225	1400
Red	625 nm	115	230	345	460	575	690	805	920
Yellow	590 nm	85	170	255	340	425	510	595	680
Blue	470 nm	65	130	195	260	325	390	455	520

Dimensions

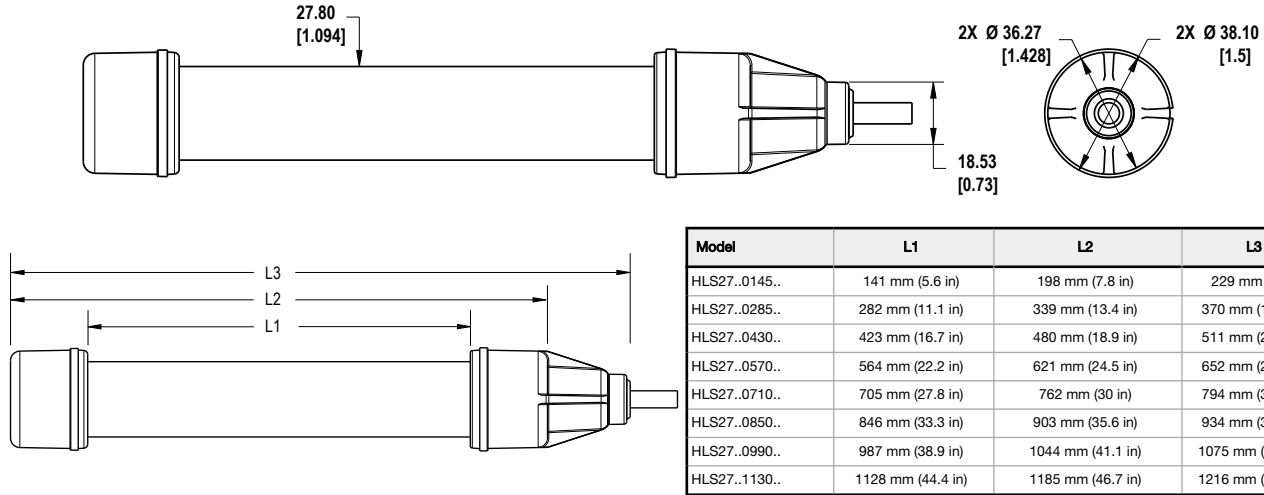

Performance

Optical data shown below is for standard single color cool white only. To get lux and candela values for other colors in both single and dual color versions, multiply the values shown on the charts by the following factors.

Single Color:

Warm White: 1.000 Red: 0.173 Blue: 0.120
 Green: 0.547 Yellow: 0.147

Dual Color:

Daylight White: 0.733 Red: 0.307 Blue: 0.173
 Green: 0.467 Yellow: 0.227

145 mm Models

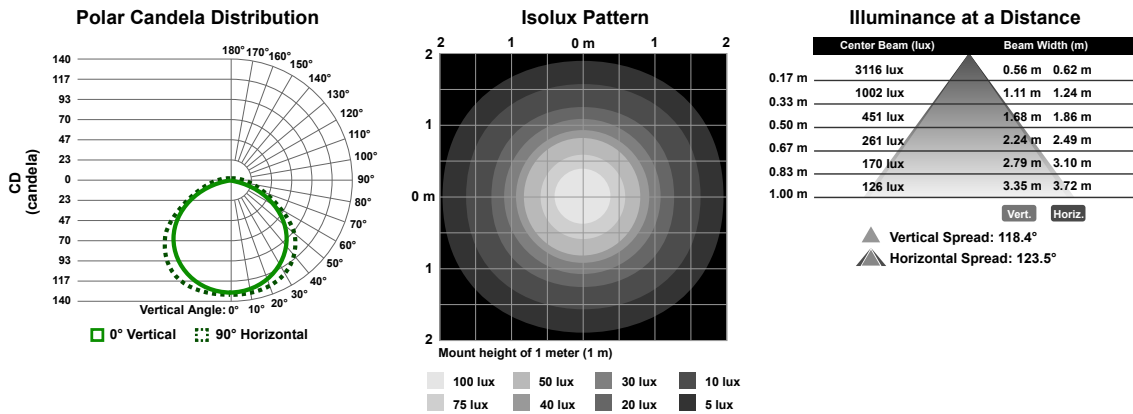

285 mm Models

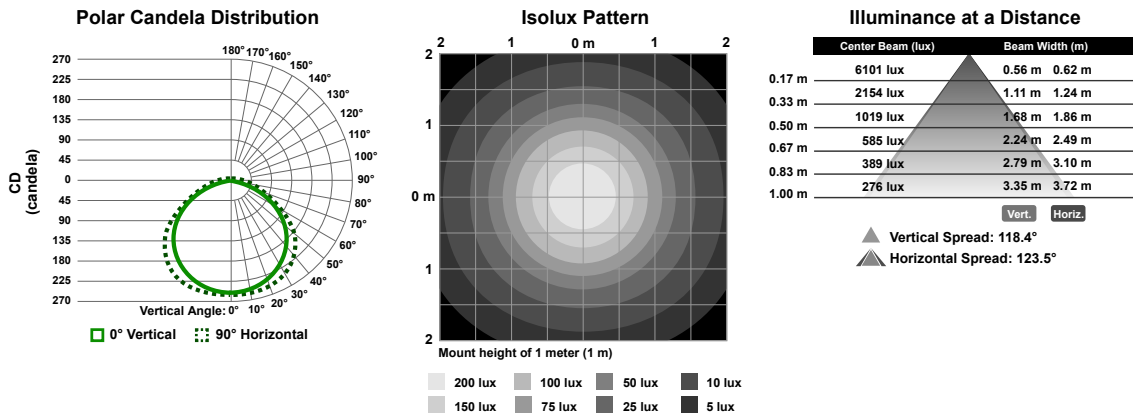

430 mm Models

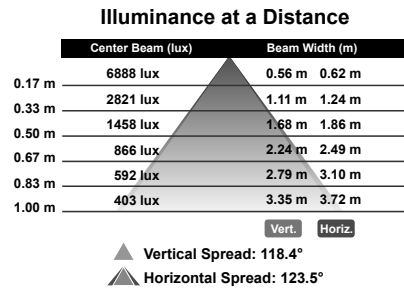
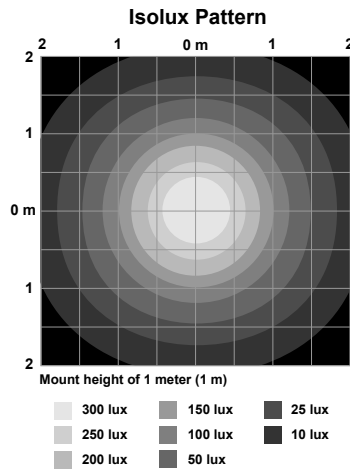
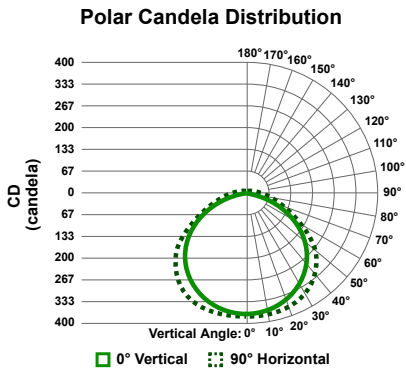

570 mm Models

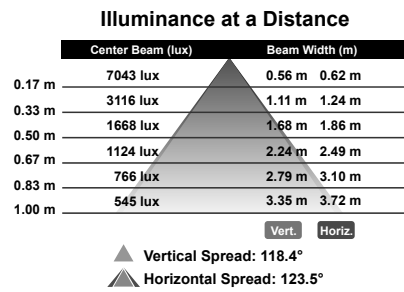
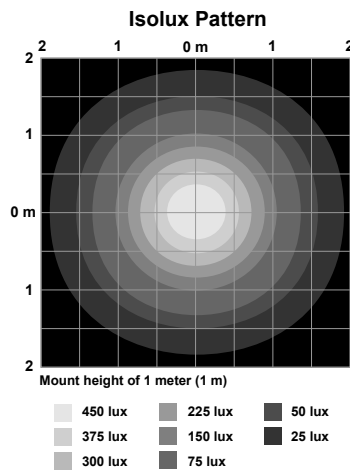
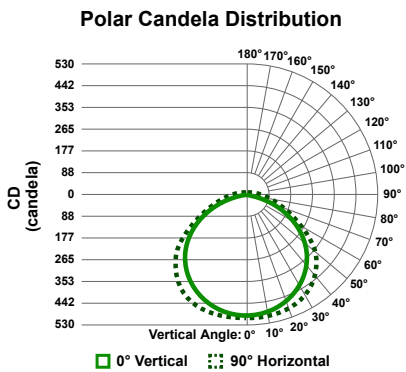

710 mm Models

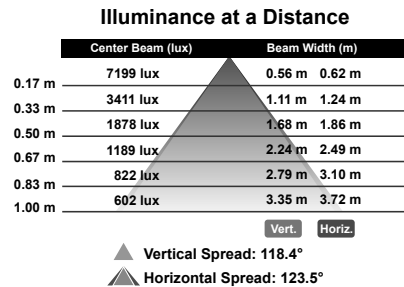
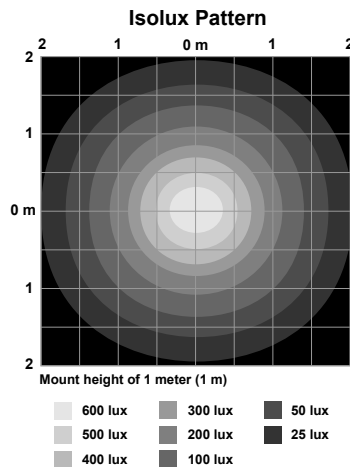
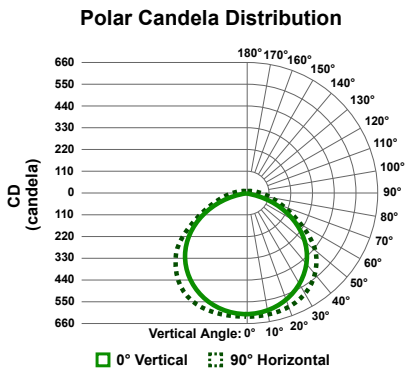

850 mm Models

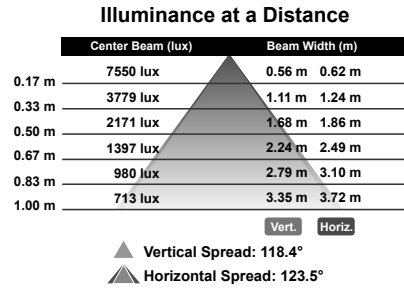
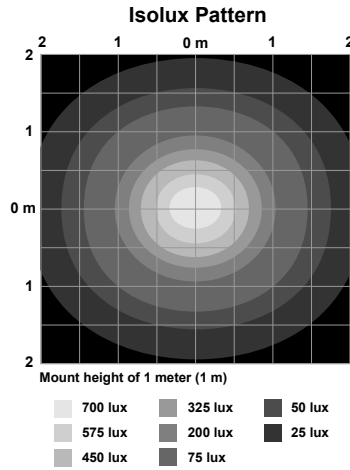
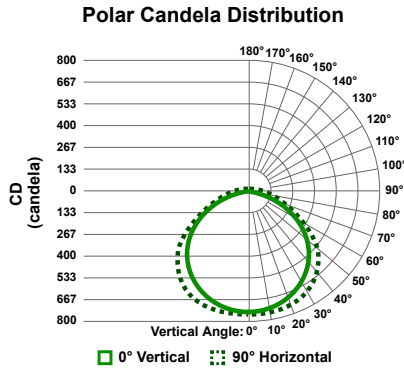

990 mm Models

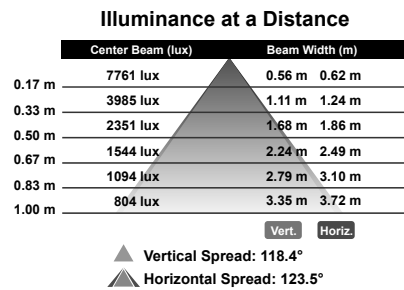
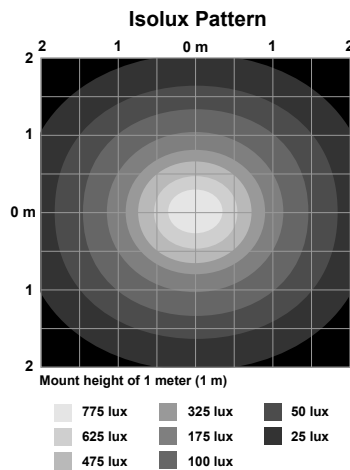
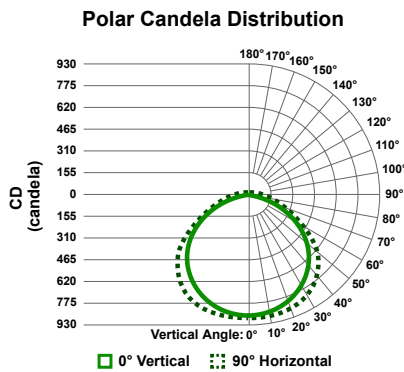

1130 mm Models

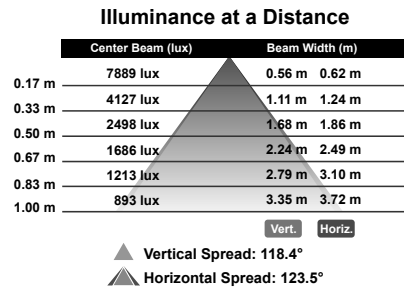
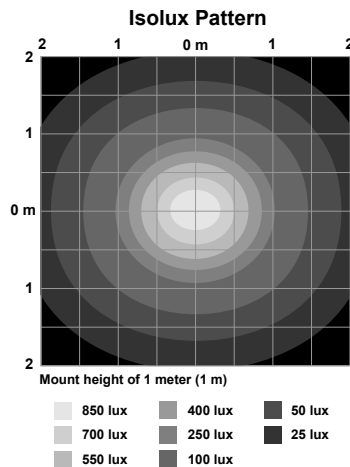
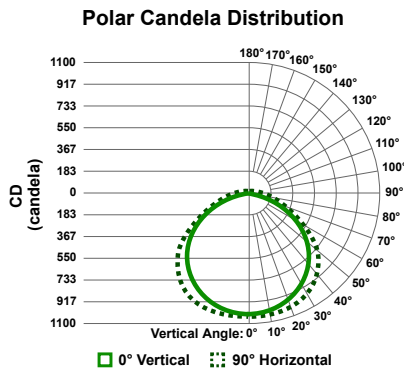

Accessories

Brackets

The following brackets can be used with the HLS27 Hazardous Location LED Strip Light.

LMBHLS27S

- Set of 2 brackets
- Impact absorbing
- 300 series stainless steel
- Clearance for M5 or #10 hardware

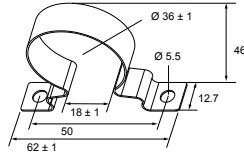

LMBHLS27O

- Set of 2 brackets
- Impact absorbing clamp
- 300 series stainless steel
- M5 stainless steel hardware included

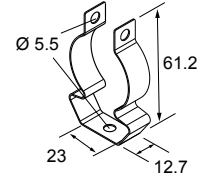

The following brackets can be used with the HLS27 Hazardous Location LED Strip Light for North America applications, but will not meet the required specifications for ATEX/IECEX.

LMBWLS27H

- 300 series stainless steel mounting brackets
- M4 stainless steel hardware included

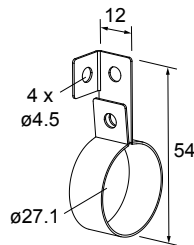

LMBWLS27U

- Clear copolyester
- Clearance for M5 or #10 hardware
- Clamps securely around the light body

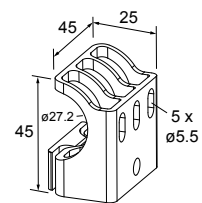

All measurements are listed in millimeters, unless noted otherwise.

Banner Engineering Corp. Limited Warranty

Banner Engineering Corp. warrants its products to be free from defects in material and workmanship for one year following the date of shipment. Banner Engineering Corp. will repair or replace, free of charge, any product of its manufacture which, at the time it is returned to the factory, is found to have been defective during the warranty period. This warranty does not cover damage or liability for misuse, abuse, or the improper application or installation of the Banner product.

THIS LIMITED WARRANTY IS EXCLUSIVE AND IN LIEU OF ALL OTHER WARRANTIES WHETHER EXPRESS OR IMPLIED (INCLUDING, WITHOUT LIMITATION, ANY WARRANTY OF MERCHANTABILITY OR FITNESS FOR A PARTICULAR PURPOSE), AND WHETHER ARISING UNDER COURSE OF PERFORMANCE, COURSE OF DEALING OR TRADE USAGE.

This Warranty is exclusive and limited to repair or, at the discretion of Banner Engineering Corp., replacement. **IN NO EVENT SHALL BANNER ENGINEERING CORP. BE LIABLE TO BUYER OR ANY OTHER PERSON OR ENTITY FOR ANY EXTRA COSTS, EXPENSES, LOSSES, LOSS OF PROFITS, OR ANY INCIDENTAL, CONSEQUENTIAL OR SPECIAL DAMAGES RESULTING FROM ANY PRODUCT DEFECT OR FROM THE USE OR INABILITY TO USE THE PRODUCT, WHETHER ARISING IN CONTRACT OR WARRANTY, STATUTE, TORT, STRICT LIABILITY, NEGLIGENCE, OR OTHERWISE.**

Banner Engineering Corp. reserves the right to change, modify or improve the design of the product without assuming any obligations or liabilities relating to any product previously manufactured by Banner Engineering Corp. Any misuse, abuse, or improper application or installation of this product or use of the product for personal protection applications when the product is identified as not intended for such purposes will void the product warranty. Any modifications to this product without prior express approval by Banner Engineering Corp will void the product warranties. All specifications published in this document are subject to change; Banner reserves the right to modify product specifications or update documentation at any time. Specifications and product information in English supersede that which is provided in any other language. For the most recent version of any documentation, refer to: www.bannerengineering.com.

For patent information, see www.bannerengineering.com/patents.

FCC Part 15 and CAN ICES-3 (B)/NMB-3(B)

This device complies with part 15 of the FCC Rules and CAN ICES-3 (B)/NMB-3(B). Operation is subject to the following two conditions:

1. This device may not cause harmful interference, and
2. This device must accept any interference received, including interference that may cause undesired operation.

This equipment has been tested and found to comply with the limits for a Class B digital device, pursuant to part 15 of the FCC Rules and CAN ICES-3 (B)/NMB-3(B). These limits are designed to provide reasonable protection against harmful interference in a residential installation. This equipment generates, uses and can radiate radio frequency energy and, if not installed and used in accordance with the instructions, may cause harmful interference to radio communications. However, there is no guarantee that interference will not occur in a particular installation. If this equipment does cause harmful interference to radio or television reception, which can be determined by turning the equipment off and on, the user is encouraged to try to correct the interference by one or more of the following measures:

- Reorient or relocate the receiving antenna.
- Increase the separation between the equipment and receiver.
- Connect the equipment into an outlet on a circuit different from that to which the receiver is connected.
- Consult the manufacturer.

Repairs

Contact Banner Engineering for troubleshooting of this device. **Do not attempt any repairs to this Banner device; it contains no field-replaceable parts or components.** If the device, device part, or device component is determined to be defective by a Banner Applications Engineer, they will advise you of Banner's RMA (Return Merchandise Authorization) procedure.



Important: If instructed to return the device, pack it with care. Damage that occurs in return shipping is not covered by warranty.